

Notice for TAIYO YUDEN Products

[For High Quality and/or Reliability Equipment
(Automotive Electronic Equipment / Industrial Equipment)]

Please read this notice before using the TAIYO YUDEN products.

REMINDERS

- Product information in this catalog is as of October 2018. All of the contents specified herein are subject to change without notice due to technical improvements, etc. Therefore, please check for the latest information carefully before practical application or use of our products.

Please note that TAIYO YUDEN shall not be in any way responsible for any damages and defects in products or equipment incorporating our products, which are caused under the conditions other than those specified in this catalog or individual product specification sheets.

- Please contact TAIYO YUDEN for further details of product specifications as the individual product specification sheets are available.
- Please conduct validation and verification of our products in actual condition of mounting and operating environment before using our products.
- The products listed in this catalog are intended for use in general electronic equipment (e.g., AV equipment, OA equipment, home electric appliances, office equipment, information and communication equipment), medical equipment classified as Class I or II by IMDRF, industrial equipment, and automotive interior applications, etc. Please be sure to contact TAIYO YUDEN for further information before using the products for any equipment which may directly cause loss of human life or bodily injury (e.g., transportation equipment including, without limitation, automotive powertrain control system, train control system, and ship control system, traffic signal equipment, medical equipment classified as Class III by IMDRF).

Please do not incorporate our products into any equipment requiring high levels of safety and/or reliability (e.g., aerospace equipment, aviation equipment*, medical equipment classified as Class IV by IMDRF, nuclear control equipment, undersea equipment, military equipment).

*Note: There is a possibility that our products can be used only for aviation equipment that does not directly affect the safe operation of aircraft (e.g., in-flight entertainment, cabin light, electric seat, cooking equipment) if such use meets requirements specified separately by TAIYO YUDEN. Please be sure to contact TAIYO YUDEN for further information before using our products for such aviation equipment.

When our products are used even for high safety and/or reliability-required devices or circuits of general electronic equipment, it is strongly recommended to perform a thorough safety evaluation prior to use of our products and to install a protection circuit as necessary.

Please note that unless you obtain prior written consent of TAIYO YUDEN, TAIYO YUDEN shall not be in any way responsible for any damages incurred by you or third parties arising from use of the products listed in this catalog for any equipment requiring inquiry to TAIYO YUDEN or prohibited for use by TAIYO YUDEN as described above.

- Information contained in this catalog is intended to convey examples of typical performances and/or applications of our products and is not intended to make any warranty with respect to the intellectual property rights or any other related rights of TAIYO YUDEN or any third parties nor grant any license under such rights.
- Please note that the scope of warranty for our products is limited to the delivered our products themselves and TAIYO YUDEN shall not be in any way responsible for any damages resulting from a fault or defect in our products. Notwithstanding the foregoing, if there is a written agreement (e.g., supply and purchase agreement, quality assurance agreement) signed by TAIYO YUDEN and your company, TAIYO YUDEN will warrant our products in accordance with such agreement.
- The contents of this catalog are applicable to our products which are purchased from our sales offices or authorized distributors (hereinafter "TAIYO YUDEN's official sales channel"). Please note that the contents of this catalog are not applicable to our products purchased from any seller other than TAIYO YUDEN's official sales channel.

■ Caution for Export

Some of our products listed in this catalog may require specific procedures for export according to "U.S. Export Administration Regulations", "Foreign Exchange and Foreign Trade Control Law" of Japan, and other applicable regulations. Should you have any questions on this matter, please contact our sales staff.

Automotive Application Guide

We classify automotive electronic equipment into the following four application categories and set usable application categories for each of our products. When using our products for automotive electronic equipment, please be sure to check such application categories and use our products accordingly. Should you have any questions on this matter, please contact us.

Category	Automotive Electronic Equipment (Typical Example)
POWERTRAIN	<ul style="list-style-type: none"> • Engine ECU (Electronically Controlled Fuel Injector) • Cruise Control Unit • 4WS (4 Wheel Steering) • Automatic Transmission • Power Steering • HEV/PHV/EV Core Control (Battery, Inverter, DC-DC) • Automotive Locator (Car location information providing device), etc.
SAFETY	<ul style="list-style-type: none"> • ABS (Anti-Lock Brake System) • ESC (Electronic Stability Control) • Airbag • ADAS (Equipment that directly controls running, turning and stopping), etc.
BODY & CHASSIS	<ul style="list-style-type: none"> • Wiper • Automatic Door • Power Window • Keyless Entry System • Electric Door Mirror • Interior Lighting • LED Headlight • TPMS (Tire Pressure Monitoring System) • Anti-Theft Device (Immobilizer), etc.
INFOTAINMENT	<ul style="list-style-type: none"> • Car Infotainment System • ITS/Telematics System • Instrument Cluster • ADAS (Sensor, Equipment that is not interlocked with safety equipment or powertrain), etc.

WIRE-WOUND CHIP POWER INDUCTORS(CB SERIES)

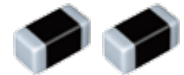

REFLOW

PART NUMBER

*Operating Temp. : -40~105°C (Including self-generated heat)

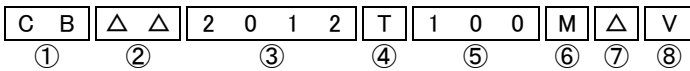

①Series name

Code	Series name
CB	Wound chip power inductor

②Characteristics

Code	Characteristics
△△	Standard
△C	High current

③Dimensions (L × W)

Code	Type (inch)	Dimensions (L × W) [mm]
2012	2012 (0805)	2.0 × 1.25
2016	2016 (0806)	2.0 × 1.6
2518	2518 (1007)	2.5 × 1.8
3225	3225 (1210)	3.2 × 2.5

④Packaging

Code	Packaging
T	Taping

⑤Nominal inductance

Code (example)	Nominal inductance [μH]
1R0	1.0
100	10
101	100

※R=Decimal point

⑥Inductance tolerance

Code	Inductance tolerance
K	±10%
M	±20%

⑦Special code

Code	Special code
△	Standard
R	Low Rdc type

⑧Internal code

Code	Internal code
V	Inductor for Industrial and Automotive

STANDARD EXTERNAL DIMENSIONS / STANDARD QUANTITY

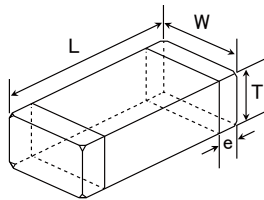

Recommended Land Patterns

Surface Mounting

- Mounting and soldering conditions should be checked beforehand.
- Applicable soldering process to these products is reflow soldering only.

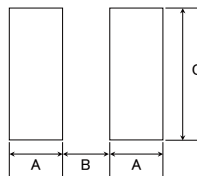

Type	A	B	C
2012	0.60	1.0	1.45
2016	0.60	1.0	1.8
2518	0.60	1.5	2.0
3225	0.85	1.7	2.7

Unit : mm

Type	L	W	T	e	Standard quantity [pcs]	
					Paper tape	Embossed tape
CB 2012	2.0±0.2	1.25±0.2	1.25±0.2	0.5±0.2	—	3000
CB C2012	(0.079±0.008)	(0.049±0.008)	(0.049±0.008)	(0.020±0.008)		
CB 2016	2.0±0.2	1.6±0.2	1.6±0.2	0.5±0.2	—	2000
CB C2016	(0.079±0.008)	(0.063±0.008)	(0.063±0.008)	(0.020±0.008)		
CB 2518	2.5±0.2	1.8±0.2	1.8±0.2	0.5±0.2	—	2000
CB C2518	(0.098±0.008)	(0.071±0.008)	(0.071±0.008)	(0.020±0.008)		
CB C3225	3.2±0.2	2.5±0.2	2.5±0.2	0.6±0.3	—	1000
	(0.126±0.008)	(0.098±0.008)	(0.098±0.008)	(0.024±0.012)		

Unit : mm (inch)

▶ This catalog contains the typical specification only due to the limitation of space. When you consider the purchase of our products, please check our product specification sheets. For details of each product (characteristics graph, reliability information, precautions for use, and so on), see our website (<http://www.ty-top.com/>).

■ PART NUMBER

• All the Wire-wound Chip Power Inductors of the catalog lineup are RoHS compliant.

Note)

- The exchange of individual specifications is necessary depending on the application and circuit condition. Please contact Taiyo Yuden sales channels.
- *2: Industrial products and Medical products

Please consult with TAIYO YUDEN's official sales channel for the details of the product specification, etc., and please review and approve TAIYO YUDEN's product specification before ordering.

Please be sure to contact us for further information before using the products for automotive electronic equipment.

● 2012 (0805) type

Part number	Nominal inductance [μH]	Inductance tolerance	Self-resonant frequency [MHz] (min.)	DC Resistance [Ω] (±30%)	Rated current ※) [mA]		Measuring frequency [MHz]	Note
					Saturation current Idc1	Temperature rise current Idc2		
CB 2012T1R0M V	1.0	±20%	100	0.15	500	700	7.96	*2
CB 2012T2R2M V	2.2	±20%	80	0.23	410	620	7.96	*2
CB 2012T3R3M V	3.3	±20%	55	0.30	330	550	7.96	*2
CB 2012T4R7M V	4.7	±20%	45	0.40	300	430	7.96	*2
CB 2012T6R8M V	6.8	±20%	38	0.47	250	350	7.96	*2
CB 2012T100□ V	10	±10%, ±20%	32	0.70	190	300	2.52	*2
CB 2012T100□RV	10	±10%, ±20%	32	0.50	200	300	2.52	*2
CB 2012T150□ V	15	±10%, ±20%	28	1.3	170	240	2.52	*2
CB 2012T220□ V	22	±10%, ±20%	16	1.7	135	220	2.52	*2
CB 2012T470□ V	47	±10%, ±20%	11	3.7	90	140	2.52	*2
CB 2012T680□ V	68	±10%, ±20%	10	6.0	70	100	2.52	*2
CB 2012T101□ V	100	±10%, ±20%	8	7.0	60	100	0.796	*2

Part number	Nominal inductance [μH]	Inductance tolerance	Self-resonant frequency [MHz] (min.)	DC Resistance [Ω] (±30%)	Rated current ※) [mA]		Measuring frequency [MHz]	Note
					Saturation current Idc1	Temperature rise current Idc2		
CB C2012T1R0M V	1.0	±20%	100	0.19	700	640	7.96	*2
CB C2012T2R2M V	2.2	±20%	70	0.33	530	485	7.96	*2
CB C2012T4R7M V	4.7	±20%	45	0.50	360	395	7.96	*2
CB C2012T100□ V	10	±10%, ±20%	40	1.2	240	255	2.52	*2
CB C2012T220□ V	22	±10%, ±20%	16	3.7	170	145	2.52	*2
CB C2012T470□ V	47	±10%, ±20%	11	5.8	120	115	2.52	*2

● 2016 (0806) type

Part number	Nominal inductance [μH]	Inductance tolerance	Self-resonant frequency [MHz] (min.)	DC Resistance [Ω] (±30%)	Rated current ※) [mA]		Measuring frequency [MHz]	Note
					Saturation current Idc1	Temperature rise current Idc2		
CB 2016T1R0M V	1.0	±20%	100	0.09	600	720	7.96	*2
CB 2016T1R5M V	1.5	±20%	80	0.11	550	650	7.96	*2
CB 2016T2R2M V	2.2	±20%	70	0.13	510	600	7.96	*2
CB 2016T3R3M V	3.3	±20%	55	0.20	400	440	7.96	*2
CB 2016T4R7M V	4.7	±20%	45	0.25	340	410	7.96	*2
CB 2016T6R8M V	6.8	±20%	38	0.35	300	330	7.96	*2
CB 2016T100□ V	10	±10%, ±20%	32	0.50	250	270	2.52	*2
CB 2016T150□ V	15	±10%, ±20%	28	0.70	210	220	2.52	*2
CB 2016T220□ V	22	±10%, ±20%	16	1.0	165	190	2.52	*2
CB 2016T330□ V	33	±10%, ±20%	14	1.7	130	140	2.52	*2
CB 2016T470□ V	47	±10%, ±20%	11	2.4	110	120	2.52	*2
CB 2016T680□ V	68	±10%, ±20%	10	3.0	90	110	2.52	*2
CB 2016T101□ V	100	±10%, ±20%	8	4.5	70	90	0.796	*2

Part number	Nominal inductance [μH]	Inductance tolerance	Self-resonant frequency [MHz] (min.)	DC Resistance [Ω] (±30%)	Rated current ※) [mA]		Measuring frequency [MHz]	Note
					Saturation current Idc1	Temperature rise current Idc2		
CB C2016T1R0M V	1.0	±20%	100	0.10	1,100	885	7.96	*2
CB C2016T1R5M V	1.5	±20%	80	0.15	1,000	775	7.96	*2
CB C2016T2R2M V	2.2	±20%	70	0.20	750	625	7.96	*2
CB C2016T3R3M V	3.3	±20%	55	0.27	600	535	7.96	*2
CB C2016T4R7M V	4.7	±20%	45	0.37	550	460	7.96	*2
CB C2016T6R8M V	6.8	±20%	38	0.59	450	360	7.96	*2
CB C2016T100□ V	10	±10%, ±20%	32	0.82	380	305	2.52	*2
CB C2016T150□ V	15	±10%, ±20%	28	1.2	300	255	2.52	*2
CB C2016T220□ V	22	±10%, ±20%	16	1.8	250	205	2.52	*2
CB C2016T330□ V	33	±10%, ±20%	14	2.8	220	165	2.52	*2
CB C2016T470□ V	47	±10%, ±20%	11	4.3	150	130	2.52	*2
CB C2016T680□ V	68	±10%, ±20%	10	7.0	130	105	2.52	*2
CB C2016T101□ V	100	±10%, ±20%	8	8.0	110	95	0.796	*2

□ Please specify the Inductance tolerance code (Kor M)

※) The saturation current value (Idc1) is the DC current value having inductance decrease down to 30%. (at 20°C)
 ※) The temperature rise current value (Idc2) is the DC current value having temperature increase by 20°C. (at 20°C)
 ※) The rated current value is following either Idc1 or Idc2, which is the lower one.

▶ This catalog contains the typical specification only due to the limitation of space. When you consider the purchase of our products, please check our product specification sheets. For details of each product (characteristics graph, reliability information, precautions for use, and so on), see our website (<http://www.ty-top.com/>).

PART NUMBER

● 2518 (1007) type

Part number	Nominal inductance [μ H]	Inductance tolerance	Self-resonant frequency [MHz] (min.)	DC Resistance [Ω] ($\pm 30\%$)	Rated current ※) [mA]		Measuring frequency [MHz]	Note
					Saturation current Idc1	Temperature rise current Idc2		
CB 2518T1R0M V	1.0	$\pm 20\%$	100	0.06	1,200	1,250	7.96	*2
CB 2518T1R5M V	1.5	$\pm 20\%$	80	0.07	650	1,100	7.96	*2
CB 2518T2R2M V	2.2	$\pm 20\%$	68	0.09	510	1,000	7.96	*2
CB 2518T3R3M V	3.3	$\pm 20\%$	54	0.11	440	900	7.96	*2
CB 2518T4R7MRV	4.7	$\pm 20\%$	46	0.10	310	820	7.96	*2
CB 2518T4R7M V	4.7	$\pm 20\%$	46	0.13	340	820	7.96	*2
CB 2518T6R8M V	6.8	$\pm 20\%$	38	0.15	270	750	7.96	*2
CB 2518T100□ V	10	$\pm 10\%$, $\pm 20\%$	30	0.25	250	600	2.52	*2
CB 2518T150□ V	15	$\pm 10\%$, $\pm 20\%$	23	0.32	180	500	2.52	*2
CB 2518T220□ V	22	$\pm 10\%$, $\pm 20\%$	19	0.50	165	390	2.52	*2
CB 2518T330□ V	33	$\pm 10\%$, $\pm 20\%$	15	0.70	130	320	2.52	*2
CB 2518T470□ V	47	$\pm 10\%$, $\pm 20\%$	12	0.95	110	270	2.52	*2
CB 2518T680□ V	68	$\pm 10\%$, $\pm 20\%$	9.5	1.5	70	210	2.52	*2
CB 2518T101□ V	100	$\pm 10\%$, $\pm 20\%$	9.0	2.1	60	190	0.796	*2
CB 2518T151□ V	150	$\pm 10\%$, $\pm 20\%$	7.0	3.2	55	140	0.796	*2
CB 2518T221□ V	220	$\pm 10\%$, $\pm 20\%$	5.5	4.5	50	110	0.796	*2
CB 2518T331□ V	330	$\pm 10\%$, $\pm 20\%$	4.5	7.0	40	90	0.796	*2
CB 2518T471□ V	470	$\pm 10\%$, $\pm 20\%$	3.5	10	35	70	0.796	*2
CB 2518T681□ V	680	$\pm 10\%$, $\pm 20\%$	3.0	17	30	50	0.796	*2
CB 2518T102□ V	1000	$\pm 10\%$, $\pm 20\%$	2.4	24	25	45	0.252	*2

Part number	Nominal inductance [μ H]	Inductance tolerance	Self-resonant frequency [MHz] (min.)	DC Resistance [Ω] ($\pm 30\%$)	Rated current ※) [mA]		Measuring frequency [MHz]	Note
					Saturation current Idc1	Temperature rise current Idc2		
CB C2518T1R0M V	1.0	$\pm 20\%$	100	0.08	1,000	775	7.96	*2
CB C2518T1R5M V	1.5	$\pm 20\%$	80	0.11	950	730	7.96	*2
CB C2518T2R2M V	2.2	$\pm 20\%$	68	0.13	890	630	7.96	*2
CB C2518T3R3M V	3.3	$\pm 20\%$	54	0.16	730	560	7.96	*2
CB C2518T4R7M V	4.7	$\pm 20\%$	41	0.20	680	510	7.96	*2
CB C2518T6R8M V	6.8	$\pm 20\%$	38	0.30	550	420	7.96	*2
CB C2518T100□ V	10	$\pm 10\%$, $\pm 20\%$	30	0.36	480	375	2.52	*2
CB C2518T150□ V	15	$\pm 10\%$, $\pm 20\%$	23	0.65	350	285	2.52	*2
CB C2518T220□ V	22	$\pm 10\%$, $\pm 20\%$	19	0.77	320	250	2.52	*2
CB C2518T330□ V	33	$\pm 10\%$, $\pm 20\%$	15	1.5	270	185	2.52	*2
CB C2518T470□ V	47	$\pm 10\%$, $\pm 20\%$	12	1.9	240	165	2.52	*2
CB C2518T680□ V	68	$\pm 10\%$, $\pm 20\%$	9.5	2.8	200	140	2.52	*2
CB C2518T101□ V	100	$\pm 10\%$, $\pm 20\%$	9.0	3.7	160	125	0.796	*2
CB C2518T151□ V	150	$\pm 10\%$, $\pm 20\%$	7.0	6.1	140	95	0.796	*2
CB C2518T221□ V	220	$\pm 10\%$, $\pm 20\%$	5.5	8.4	115	80	0.796	*2
CB C2518T331□ V	330	$\pm 10\%$, $\pm 20\%$	4.5	12.3	100	65	0.796	*2
CB C2518T471□ V	470	$\pm 10\%$, $\pm 20\%$	3.5	22	80	50	0.796	*2
CB C2518T681□ V	680	$\pm 10\%$, $\pm 20\%$	3.0	28	65	45	0.796	*2

● 3225 (1210) type

Part number	Nominal inductance [μ H]	Inductance tolerance	Self-resonant frequency [MHz] (min.)	DC Resistance [Ω] ($\pm 30\%$)	Rated current ※) [mA]		Measuring frequency [MHz]	Note
					Saturation current Idc1	Temperature rise current Idc2		
CB C3225T1R0MRV	1.0	$\pm 20\%$	250	0.055	2,000	1,100	0.1	*2
CB C3225T1R5MRV	1.5	$\pm 20\%$	220	0.060	2,000	1,000	0.1	*2
CB C3225T2R2MRV	2.2	$\pm 20\%$	190	0.080	2,000	930	0.1	*2
CB C3225T3R3MRV	3.3	$\pm 20\%$	160	0.095	2,000	850	0.1	*2
CB C3225T4R7MRV	4.7	$\pm 20\%$	70	0.100	1,250	830	0.1	*2
CB C3225T6R8MRV	6.8	$\pm 20\%$	50	0.120	950	760	0.1	*2
CB C3225T100□RV	10	$\pm 10\%$, $\pm 20\%$	23	0.133	900	720	0.1	*2
CB C3225T150□RV	15	$\pm 10\%$, $\pm 20\%$	20	0.195	730	590	0.1	*2
CB C3225T220□RV	22	$\pm 10\%$, $\pm 20\%$	17	0.27	620	500	0.1	*2
CB C3225T330□RV	33	$\pm 10\%$, $\pm 20\%$	13	0.41	500	400	0.1	*2
CB C3225T470□RV	47	$\pm 10\%$, $\pm 20\%$	10	0.67	390	320	0.1	*2
CB C3225T680□RV	68	$\pm 10\%$, $\pm 20\%$	8.0	1.0	320	260	0.1	*2
CB C3225T101□RV	100	$\pm 10\%$, $\pm 20\%$	6.0	1.4	270	220	0.1	*2
CB C3225T221□RV	220	$\pm 10\%$, $\pm 20\%$	3.0	2.5	190	170	0.1	*2
CB C3225T821□RV	820	$\pm 10\%$, $\pm 20\%$	1.8	12	110	80	0.1	*2
CB C3225T102□RV	1000	$\pm 10\%$, $\pm 20\%$	1.6	13	100	75	0.1	*2

□ Please specify the Inductance tolerance code (Kor M)

※) The saturation current value (Idc1) is the DC current value having inductance decrease down to 30%. (at 20°C)

※) The temperature rise current value (Idc2) is the DC current value having temperature increase by 20°C. (at 20°C)

※) The rated current value is following either Idc1 or Idc2, which is the lower one.

Derating of Rated Current

● CB series

Derating of current is necessary for CB series depending on ambient temperature. Please refer to the chart shown below for appropriate derating of current.

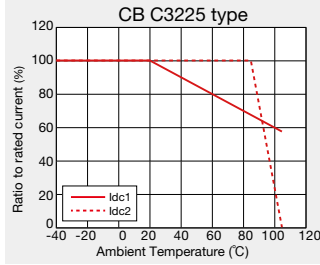
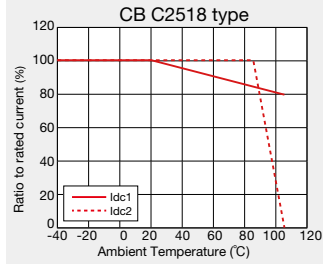
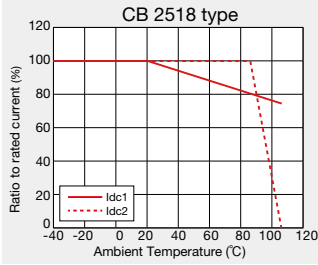
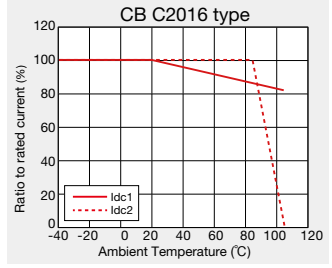
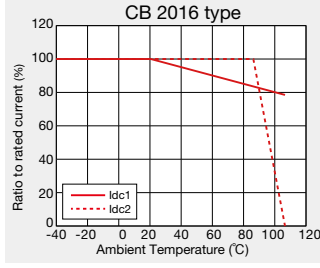
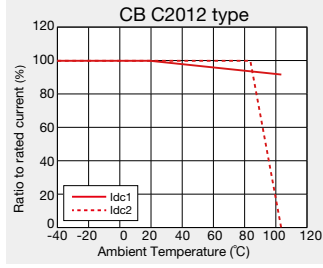
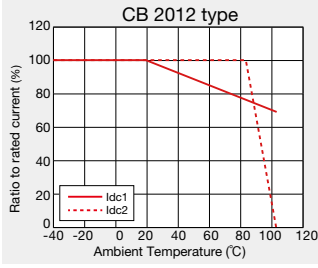

▶ This catalog contains the typical specification only due to the limitation of space. When you consider the purchase of our products, please check our product specification sheets. For details of each product (characteristics graph, reliability information, precautions for use, and so on), see our website (<http://www.ty-top.com/>).

WIRE-WOUND CHIP INDUCTORS (LB SERIES), WIRE-WOUND CHIP POWER INDUCTORS (CB SERIES), WIRE-WOUND CHIP INDUCTORS FOR SIGNAL LINES (LB SERIES M TYPE)

PACKAGING

① Minimum Quantity

Type	Standard Quantity [pcs]	
	Paper Tape	Embossed Tape
LB C3225	—	1000
CB C3225	—	1000
LB 3218	—	2000
LB R2518	—	2000
LB C2518	—	2000
LB 2518	—	2000
CB 2518	—	2000
CB C2518	—	2000
LBM2016	—	2000
LB C2016	—	2000
LB 2016	—	2000
CB 2016	—	2000
CB C2016	—	2000
LB 2012	—	3000
LB C2012	—	3000
LB R2012	—	3000
CB 2012	—	3000
CB C2012	—	3000
CB L2012	4000	—
LB 1608	4000	—
LBMF1608	—	3000
CBMF1608	—	3000

② Tape material

● Embossed tape

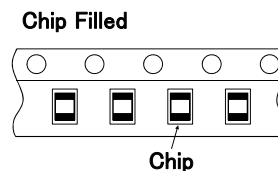
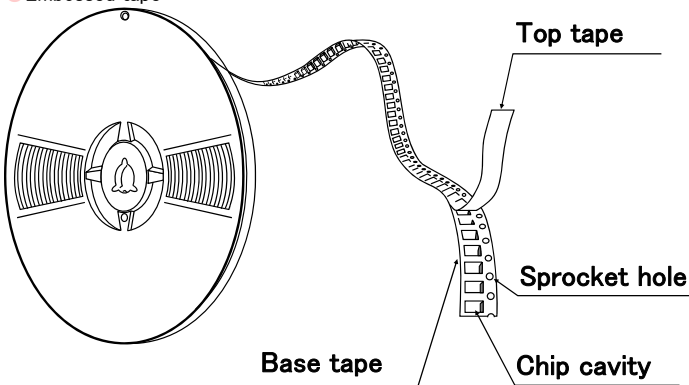

● Card board carrier tape

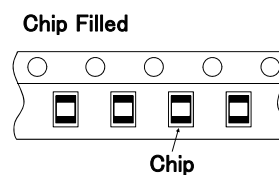
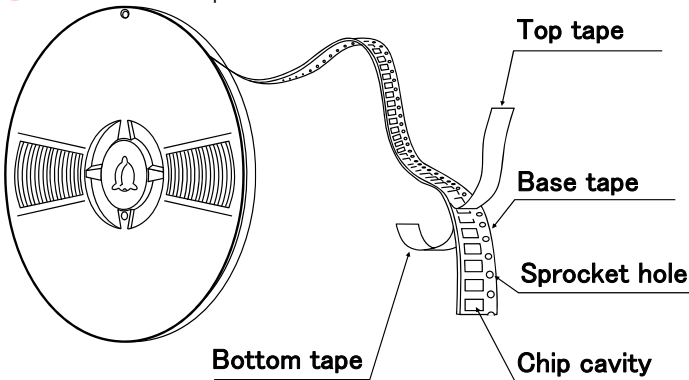

▶ This catalog contains the typical specification only due to the limitation of space. When you consider the purchase of our products, please check our specification. For details of each product (characteristics graph, reliability information, precautions for use, and so on), see our Web site (<http://www.ty-top.com/>).

③ Taping Dimensions

● Embossed Tape (0.315 inches wide)

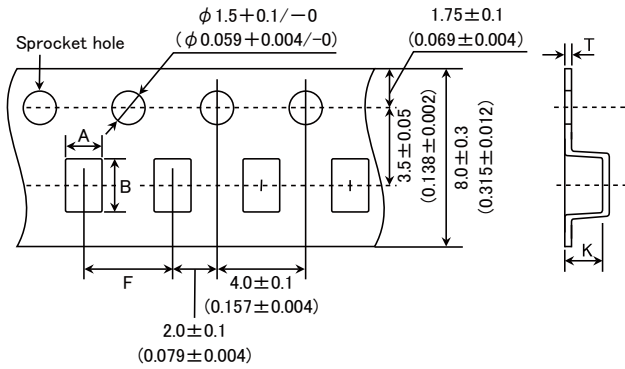

Type	Chip cavity		Insertion pitch	Tape thickness	
	A	B	F	T	K
LBM2016	1.75 ± 0.1 (0.069 ± 0.004)	2.1 ± 0.1 (0.083 ± 0.004)	4.0 ± 0.1 (0.157 ± 0.004)	0.3 ± 0.05 (0.012 ± 0.002)	1.9max. (0.075max.)
LB C3225 CB C3225	2.8 ± 0.1 (0.110 ± 0.004)	3.5 ± 0.1 (0.138 ± 0.004)	4.0 ± 0.1 (0.157 ± 0.004)	0.3 ± 0.05 (0.012 ± 0.002)	4.0max. (0.157max.)
LB 3218	2.1 ± 0.1 (0.083 ± 0.004)	3.5 ± 0.1 (0.138 ± 0.004)	4.0 ± 0.1 (0.157 ± 0.004)	0.3 ± 0.05 (0.012 ± 0.002)	2.2max. (0.087max.)
LB 2518 CB 2518 LB C2518 CB C2518 LB R2518	2.15 ± 0.1 (0.085 ± 0.004)	2.7 ± 0.1 (0.106 ± 0.004)	4.0 ± 0.1 (0.157 ± 0.004)	0.3 ± 0.05 (0.012 ± 0.002)	2.2max. (0.087max.)
LB 2016 CB 2016 LB C2016 CB C2016	1.75 ± 0.1 (0.069 ± 0.004)	2.1 ± 0.1 (0.083 ± 0.004)	4.0 ± 0.1 (0.157 ± 0.004)	0.3 ± 0.05 (0.012 ± 0.002)	1.9max. (0.075max.)
LB 2012 CB 2012 LB C2012 CB C2012 LB R2012	1.45 ± 0.1 (0.057 ± 0.004)	2.25 ± 0.1 (0.089 ± 0.004)	4.0 ± 0.1 (0.157 ± 0.004)	0.25 ± 0.05 (0.010 ± 0.002)	1.45max. (0.057max.)
LBMF1608 CBMF1608	1.1 ± 0.1 (0.043 ± 0.004)	1.9 ± 0.1 (0.075 ± 0.004)	4.0 ± 0.1 (0.157 ± 0.004)	0.25 ± 0.05 (0.010 ± 0.002)	1.2max. (0.047max.)

Unit: mm (inch)

● Card board carrier tape (0.315 inches wide)

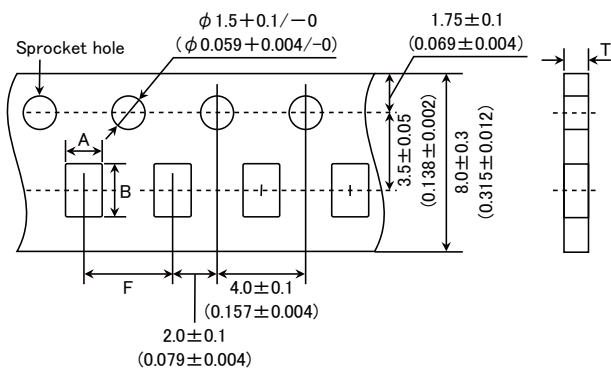

Type	Chip cavity		Insertion pitch	Tape thickness
	A	B	F	T
CB L2012	1.55 ± 0.1 (0.061 ± 0.004)	2.3 ± 0.1 (0.091 ± 0.004)	4.0 ± 0.1 (0.157 ± 0.004)	1.1max. (0.043max.)
LB 1608	1.0 ± 0.1 (0.039 ± 0.004)	1.8 ± 0.1 (0.071 ± 0.004)	4.0 ± 0.1 (0.157 ± 0.004)	1.1max. (0.043max.)

Unit: mm (inch)

④ Leader and Blank Portion

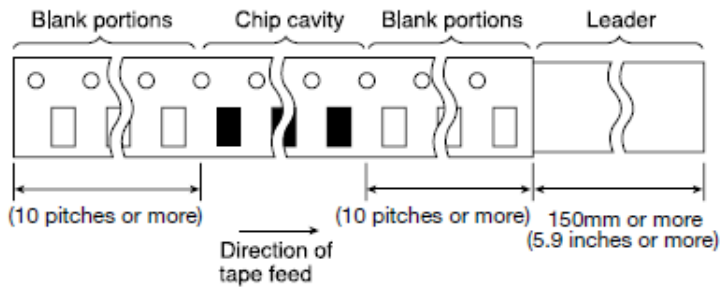

⑤ Reel Size

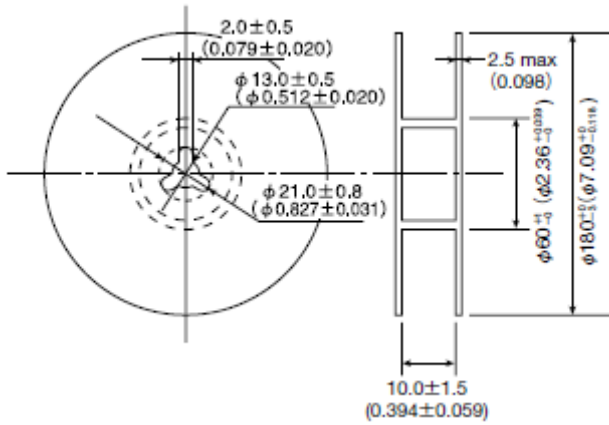

⑥ Top Tape Strength

The top tape requires a peel-off force 0.2 to 0.7N in the direction of the arrow as illustrated below.

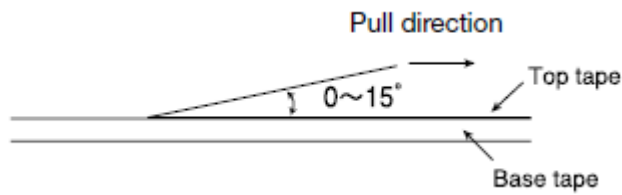

**WIRE-WOUND CHIP INDUCTORS (LB SERIES),
WIRE-WOUND CHIP POWER INDUCTORS (CB SERIES),
WIRE-WOUND CHIP INDUCTORS FOR SIGNAL LINES (LB SERIES M TYPE)**

■ RELIABILITY DATA

1. Operating temperature Range		
Specified Value	LB, LBC, LBR Series	-40~ +105°C (Including self-generated heat)
	CB, CBC Series	
	LBM Series	
Test Methods and Remarks	Including self-generated heat	

2. Storage Temperature Range (after soldering)		
Specified Value	LB, LBC, LBR Series	-40~ +85°C
	CB, CBC Series	
	LBM Series	
Test Methods and Remarks	LB, CB Series : Please refer the term of "7. storage conditions" in precautions.	

3. Rated Current		
Specified Value	LB, LBC, LBR Series	Within the specified tolerance
	CB, CBC Series	
	LBM Series	

4. Inductance		
Specified Value	LB, LBC, LBR Series	Within the specified tolerance
	CB, CBC Series	
	LBM Series	
Test Methods and Remarks	LB・LBC・LBR・CB・CBC・LBM Series Measuring equipment : LCR Meter (HP4285A or its equivalent)	

5. Q		
Specified Value	LB, LBC, LBR Series	-
	CB, CBC Series	
	LBM Series	Within the specified tolerance
Test Methods and Remarks	LBM Series Measuring equipment : LCR Meter (HP4285A or its equivalent)	

6. DC Resistance		
Specified Value	LB, LBC, LBR Series	Within the specified tolerance
	CB, CBC Series	
	LBM Series	
Test Methods and Remarks	Measuring equipment : DC Ohmmeter (HIOKI 3227 or its equivalent)	

7. Self-Resonant Frequency		
Specified Value	LB, LBC, LBR Series	Within the specified tolerance
	CB, CBC Series	
	LBM Series	
Test Methods and Remarks	Measuring equipment : Impedance analyzer (HP4291A or its equivalent)	

▶ This catalog contains the typical specification only due to the limitation of space. When you consider the purchase of our products, please check our specification.
For details of each product (characteristics graph, reliability information, precautions for use, and so on), see our Web site (<http://www.ty-top.com/>).

8. Temperature Characteristic					
Specified Value	LBM2016				Inductance change : Within $\pm 10\%$
	LB2012	LBR2012	CB2012	LB2016	Inductance change : Within $\pm 20\%$
	CB2016	LB2518	LBR2518	CB2518	
	LBC3225	CBC3225			
	LBC2016	CBC2016	LBC2518	CBC2518	Inductance change : Within $\pm 25\%$
LB3218					
	LBC2012	CBC2012			Inductance change : Within $\pm 35\%$
Test Methods and Remarks	Change of maximum inductance deviation in step 1-5				
	Step	Temperature ($^{\circ}\text{C}$)			
		LB, CB Serie			
	1	20			
	2	-40			
	3	20 (Reference temperature)			
	4	+85 (Maximum operating temperature)			
5	20				

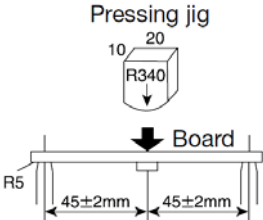
9. Resistance to Flexure of Substrate			
Specified Value	LB, LBC, LBR Series		No damage.
	CB, CBC Series		
	LBM Series		
Test Methods and Remarks	Warp : 2mm (LB·LBC·LBR·CB·CBC·LBM Series) Test substrate : Board according to JIS C0051 Thickness : 1.0mm		
			

10. Body Strength			
Specified Value	LB, LBC, LBR Series		No damage.
	CB, CBC Series		
	LBM Series		
Test Methods and Remarks	LB·LBC·LBR·CB·CBC·LBM Applied force : 10N Duration : 10sec.		

11. Adhesion of terminal electrode			
Specified Value	LB, LBC, LBR Series		No abnormality.
	CB, CBC Series		
	LBM Series		
Test Methods and Remarks	LB·LBC·LBR·CB·CBC·CBL·LBM Applied force : 10N to X and Y directions Duration : 5 sec. Test substrate : Printed board		

12. Resistance to vibration		
Specified Value	LB, LBC, LBR Series	Inductance change : Within $\pm 20\%$ No significant abnormality in appearance.
	CB, CBC Series	
	LBM Series	Inductance change : Within $\pm 20\%$ No significant abnormality in appearance.
Test Methods and Remarks	LB•LBR•LBC•CB•CBC•LBM : According to JIS C5102 clause 8.2. Vibration type : A Directions : 2 hrs each in X, Y and Z directions. Total: 6 hrs Frequency range : 10 to 55 to 10 Hz (1min.) Amplitude : 1.5mm Mounting method : Soldering onto printed board Recovery : At least 2 hrs of recovery under the standard condition after the test, followed by the measurement within 48 hrs.	
13. Drop test		
Specified Value	LB, LBC, LBR Series	—
	CB, CBC Series	
	LBM Series	
14. Solderability		
Specified Value	LB, LBC, LBR Series	At least 90% of surface of terminal electrode is covered by new
	CB, CBC Series	
	LBM Series	
Test Methods and Remarks	LB•LBC•LBR•CB•CBC•CBL•LBM : Solder temperature : $245 \pm 5^\circ\text{C}$ Duration : $5 \pm 0.5\text{sec}$ Flux : Methanol solution with 25% of colophony	
15. Resistance to soldering		
Specified Value	LB, LBC, LBR Series	Inductance change : Within $\pm 20\%$
	CB, CBC Series	
	LBM Series	Inductance change : Within $\pm 20\%$
Test Methods and Remarks	LB•LBC•LBR•CB•CBC•CBL•LBM : 3 times of reflow oven at 230°C MIN for 40sec. with peak temperature at 260°C for 5sec.	
16. Resistance to solvent		
Specified Value	LB, LBC, LBR Series	—
	CB, CBC Series	
	LBM Series	
Test Methods and Remarks	Solvent temperature : Room temperature Type of solvent : Isopropyl alcohol Cleaning conditions : 90s. Immersion and cleaning.	
17. Thermal shock		
Specified Value	LB, LBC, LBR Series	Inductance change : Within $\pm 20\%$ No significant abnormality in appearance.
	CB, CBC Series	
	LBM Series	
Test Methods and Remarks	LB•LBC•LBR•CB•CBC•CBL•LBM : $-40 \sim +85^\circ\text{C}$, maintain times 30min. ,100 cycle Recovery : At least 2 hrs of recovery under the standard condition after the test, followed by the measurement within 48 hrs.	

18.Damp heat life test		
Specified Value	LB, LBC, LBR Series	Inductance change : Within $\pm 20\%$ No significant abnormality in appearance.
	CB, CBC Series	
	LBM Series	
Test Methods and Remarks	Temperature : $60 \pm 2^\circ\text{C}$ Humidity : $90 \sim 95\% \text{RH}$ Duration : 1000 hrs Recovery : At least 2 hrs of recovery under the standard condition after the test, followed by the measurement within 48 hrs.	

19.Loading under damp heat life test		
Specified Value	LB, LBC, LBR Series	Inductance change : Within $\pm 20\%$ No significant abnormality in appearance.
	CB, CBC Series	
	LBM Series	
Test Methods and Remarks	Temperature : $60 \pm 2^\circ\text{C}$ Humidity : $90 \sim 95\% \text{RH}$ Duration : 1000 hrs Applied current : Rated current Recovery : At least 2 hrs of recovery under the standard condition after the test, followed by the measurement within 48 hrs.	

20.High temperature life test		
Specified Value	LB, LBC, LBR Series	—
	CB, CBC Series	Inductance change : Within $\pm 20\%$ No significant abnormality in appearance.
	LBM Series	
Test Methods and Remarks	Temperature : $85 \pm 2^\circ\text{C}$ Duration : 1000 hrs Recovery : At least 2 hrs of recovery under the standard condition after the test, followed by the measurement within 48 hrs.	

21.Loading at high temperature life test		
Specified Value	LB, LBC, LBR Series	Inductance change : Within $\pm 20\%$ No significant abnormality in appearance.
	CB, CBC Series	
	LBM Series	—
Test Methods and Remarks	Temperature : $85 \pm 2^\circ\text{C}$ Duration : 1000 hrs Applied current : Rated current Recovery : At least 2 hrs of recovery under the standard condition after the test, followed by the measurement within 48 hrs.	

22.Low temperature life test		
Specified Value	LB, LBC, LBR Series	Inductance change : Within $\pm 20\%$ No significant abnormality in appearance.
	CB, CBC Series	
	LBM Series	
Test Methods and Remarks	Temperature : $-40 \pm 2^\circ\text{C}$ Duration : 1000 hrs Recovery : At least 2 hrs of recovery under the standard condition after the test, followed by the measurement within 48 hrs.	

23.Standard condition		
Specified Value	LB, LBC, LBR Series	Standard test conditions Unless specified, Ambient temperature is $20 \pm 15^\circ\text{C}$ and the Relative humidity is $65 \pm 20\%$. If there is any doubt about the test results, further measurement shall be had within the following limits: Ambient Temperature: $20 \pm 2^\circ\text{C}$ Relative humidity: $65 \pm 5\%$ Inductance value is based on our standard measurement systems.
	CB, CBC Series	
	LBM Series	

WIRE-WOUND CHIP INDUCTORS (LB SERIES), WIRE-WOUND CHIP POWER INDUCTORS (CB SERIES), WIRE-WOUND CHIP INDUCTORS FOR SIGNAL LINES (LB SERIES M TYPE)

■ PRECAUTIONS

1. Circuit Design	
Precautions	<p>◆Operating environment</p> <p>1. The products listed in this catalogue are intended for use in general electronic equipment (e.g., AV equipment, OA equipment, home electric appliances, office equipment, information and communication equipment), general medical equipment, industrial equipment, and automotive interior applications, etc.</p> <p>Please be sure to contact TAIYO YUDEN for further information before using the products for any equipment which may directly cause loss of human life or bodily injury (e.g., specially controlled medical equipment, transportation equipment including, without limitation, automotive powertrain control system, train control system, and ship control system, traffic signal equipment).</p> <p>Please do not incorporate our products into any equipment requiring high levels of safety and/or reliability (e.g., aerospace equipment, aviation equipment, nuclear control equipment, undersea equipment, military equipment, etc.).</p>
2. PCB Design	
Precautions	<p>◆Land pattern design</p> <p>1. Please contact any of our offices for a land pattern, and refer to a recommended land pattern of a right figure or specifications.</p>
Technical considerations	<p>PRECAUTIONS 【Recommended Land Patterns】</p> <p>Surface Mounting</p> <ul style="list-style-type: none"> • Mounting and soldering conditions should be checked beforehand. • Applicable soldering process to those products is reflow soldering only.
3. Considerations for automatic placement	
Precautions	<p>◆Adjustment of mounting machine</p> <p>1. Excessive impact load should not be imposed on the products when mounting onto the PC boards.</p> <p>2. Mounting and soldering conditions should be checked beforehand.</p>
Technical considerations	<p>1. When installing products, care should be taken not to apply distortion stress as it may deform the products.</p>
4. Soldering	
Precautions	<p>◆Reflow soldering (LB and CB Types)</p> <p>1. For reflow soldering with either leaded or lead-free solder, the profile specified in "point for controlling" is recommended.</p> <p>◆Recommended conditions for using a soldering iron</p> <p>1. Put the soldering iron on the land-pattern. Soldering iron's temperature – Below 350°C Duration-3 seconds or less. The soldering iron should not come in contact with inductor directly.</p>
Technical considerations	<p>◆Reflow soldering (LB and CB Types)</p> <p>1. Reflow profile</p> <p>◆Recommended conditions for using a soldering iron</p> <p>1. Components can be damaged by excessive heat where soldering conditions exceed the specified range.</p>
5. Cleaning	
Precautions	<p>◆Cleaning conditions</p> <p>Washing by supersonic waves shall be avoided.</p>
Technical considerations	<p>◆Cleaning conditions</p> <p>If washed by supersonic waves, the products might be broken.</p>

▶ This catalog contains the typical specification only due to the limitation of space. When you consider the purchase of our products, please check our specification. For details of each product (characteristics graph, reliability information, precautions for use, and so on), see our Web site (<http://www.ty-top.com/>).

6. Handling

Precautions	<ul style="list-style-type: none">◆ Handling<ul style="list-style-type: none">1. Keep the inductors away from all magnets and magnetic objects.◆ Breakaway PC boards (splitting along perforations)<ul style="list-style-type: none">1. When splitting the PC board after mounting inductors, care should be taken not to give any stresses of deflection or twisting to the board.2. Board separation should not be done manually, but by using the appropriate devices.◆ Mechanical considerations<ul style="list-style-type: none">1. Please do not give the inductors any excessive mechanical shocks.
Technical considerations	<ul style="list-style-type: none">◆ Handling<ul style="list-style-type: none">1. There is a case that a characteristic varies with magnetic influence.◆ Breakaway PC boards (splitting along perforations)<ul style="list-style-type: none">1. Planning pattern configurations and the position of products should be carefully performed to minimize stress.◆ Mechanical considerations<ul style="list-style-type: none">1. There is a case to be damaged by a mechanical shock.

7. Storage conditions

Precautions	<ul style="list-style-type: none">◆ Storage<ul style="list-style-type: none">1. To maintain the solderability of terminal electrodes and to keep the packing material in good condition, temperature and humidity in the storage area should be controlled.<ul style="list-style-type: none">• Recommended conditions Ambient temperature: 0~40°C / Humidity: Below 70% RH <p>The ambient temperature must be kept below 30°C even under ideal storage conditions, solderability of products electrodes may decrease as time passes. For this reason, These series should be used within 6 months from the time of delivery.</p>
Technical considerations	<ul style="list-style-type: none">◆ Storage<ul style="list-style-type: none">1. Under a high temperature and humidity environment, problems such as reduced solderability caused by oxidation of terminal electrodes and deterioration of taping/packaging materials may take place.

► This catalog contains the typical specification only due to the limitation of space. When you consider the purchase of our products, please check our specification.
For details of each product (characteristics graph, reliability information, precautions for use, and so on), see our Web site (<http://www.ty-top.com/>).